BROOKLYN

Tasarım Nurus D Lab

Teknik Doküman

nurus

Brooklyn, geometrik formu ve sağlam yapısıyla ismini aldığı Brooklyn Köprüsü'nün gücünü yansıtıyor.

Brooklyn'in ayakları hassas matematiksel hesaplamalar ve hata toleransını en aza indiren son teknoloji üretim teknikleriyle; beklenmedik formlarda, neredeyse bir ağ gibi örülerek şekillendirilmiştir. Dikkat çeken metal ayaklarındaki kontrast, tepeden zemine doğru hiperbolik bir görüntü oluşturarak daralmaktadır.

Brooklyn; yönetici masaları, toplantı masaları, sehpa ve depolama ünitelerinden oluşan geniş ailesi ile hem çalışma alanınızın hem de kurumun aynı tasarım diliyle düzenlenmesine yardımcı oluyor.



Tasarım



Nurus D Lab

Nurus D Lab (Nurus Design Lab), markanın tasarım stratejisinin belirlenmesinden ürünün pazara sunulmasına kadar tüm aşamalarda etkindir. Üretim geliştirme sürecinde Nurus D Lab, diğer tasarımcılarla da uyum ve işbirliği içinde çalışır. Tasarımların başlangıç noktası, kullanıcıların gereksinimleri ve fonksiyondur. Ergonomi, sürdürülebilirlik ve estetik kaygılarla devam eden süreçte bilimsel ve teknolojik gelişmeleri takip ederek güncelliğini korur.

İnsan olmak,
kendi ihtiyaçlarımız kadar
bizden sonrakileri de
düşünebilmektir.

Brooklyn, Türk Standartlarına Uygunluk Belgesine (TSE) sahiptir. Üretiminde kullanılan malzemeler ürün ömrü sonunda tekrar kullanılabilir ya da geri dönüştürülebilir. Brooklyn'in üretiminde kullanılan metal parçalar %100 geri dönüştürülebilir ve E1 standardındaki ahşap %100 oranında tekrar kullanılabilir.



Versiyonlar

Yönetici Masaları

2 Ayaklı Masa



Komodun Ayaklı Masa



2 Ayaklı Masa + Tek Ayaklı Yan Masa



Komodun Ayaklı Yan Masa



*Komodin ayaklı masalarda 3 çekmece ve 1 çekmece + 1 ADD seçeneği bulunmaktadır.

Ölçüler (mm)

Yönetici Masaları

2 Ayaklı Masa

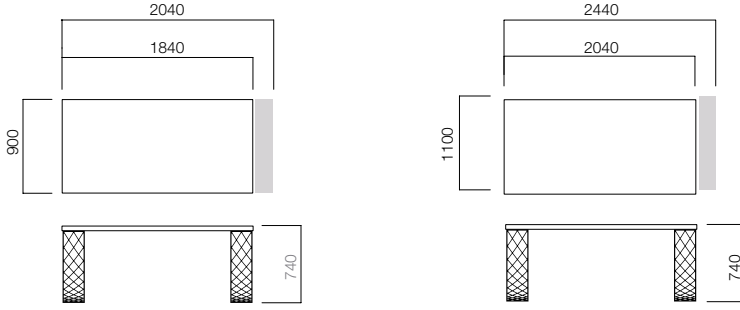

Komodün Ayaklı Masa

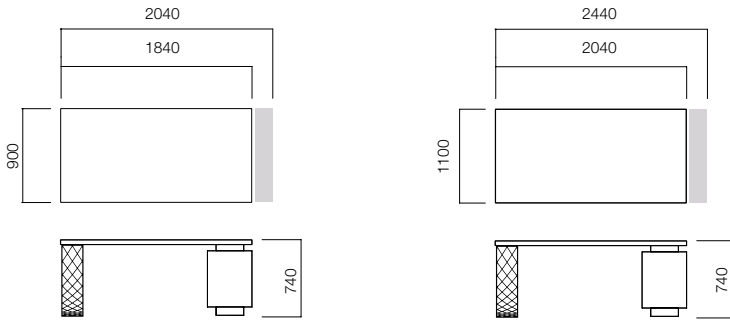

Komodün Ayaklı Yan Masa

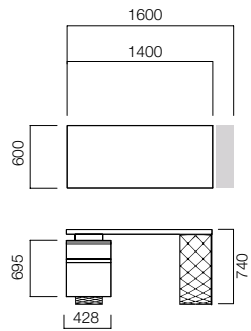

Versiyonlar

Toplantı Masaları

W:90/110cm Toplantı Masası



Elips Toplantı Masası



Dairesel Toplantı Masası



Ölçüler (mm)

Toplantı Masaları

Dairesel Toplantı Masası

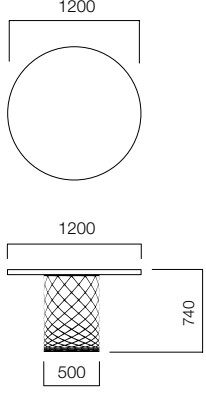

Elips Toplantı Masası

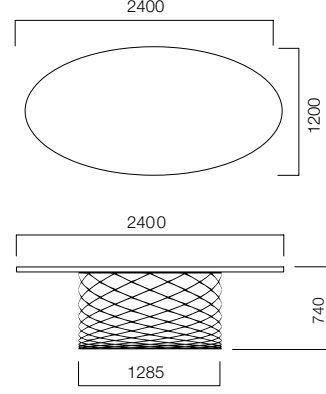

W:90/110 cm Toplantı Masası

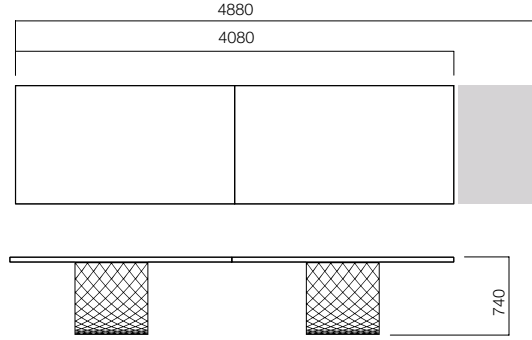
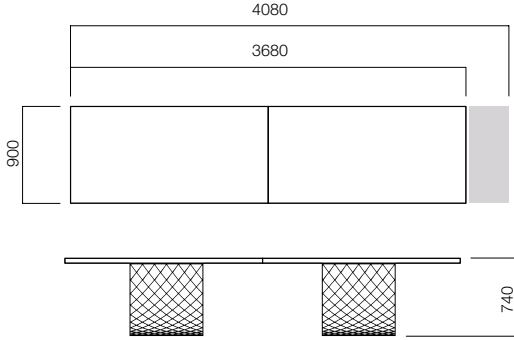

*Elips ve dairesele masalarda cam tabla alternatifi bulunmaktadir.

**Cam tablalı masalarda yükseklik h:719 mm'dir.

Versiyonlar

Depolama

H:74 cm Dolap



H:166 cm Alt Dolaplı Tekli Açık Dolap



H:166 cm Tekli Açık Dolap



H:166 cm İkili Açık Dolap



Ölçüler (mm)

Depolama

H:74 cm Dolap

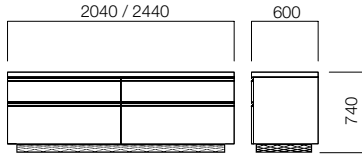

H:122 cm Tekli Açık Dolap

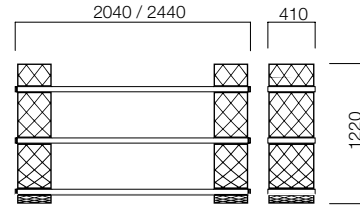

H:166 cm Tekli Açık Dolap

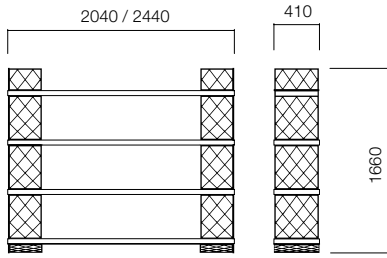

H:166 cm Alt Dolaplı Tekli Açık Dolap

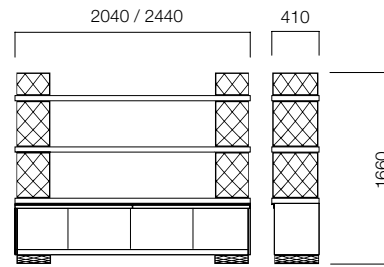

H:122 cm Alt Dolaplı Tekli Açık Dolap

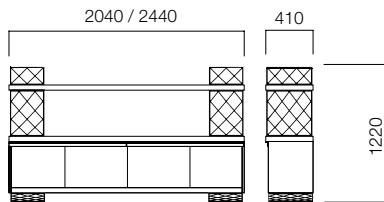

H:166 cm İkili Açık Dolap

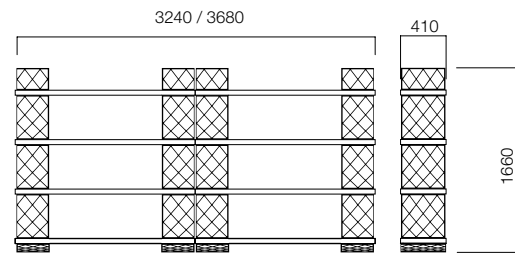

Versiyonlar

Sehpalar

Sehpa



Ölçüler (mm)

Sehpalar

Dairesel Sehpa

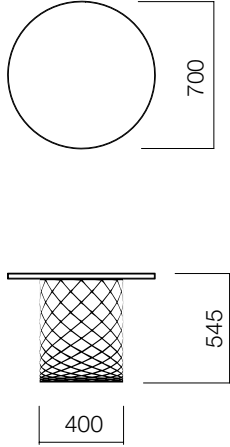

Elips Sehpa

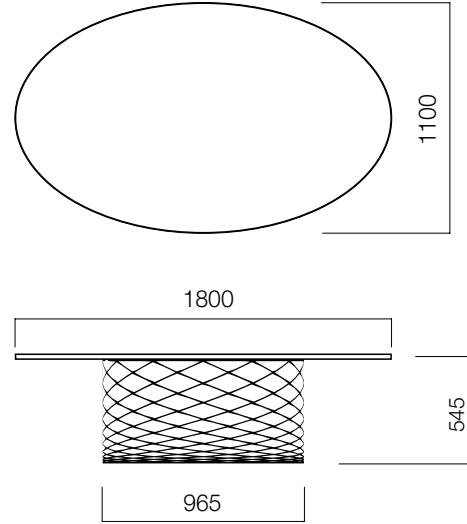

*Dairesel ve elips sehpalarda cam tabla alternatifi bulunmaktadır.

**Cam tablalı sehpalarda yükseklik h:524 mm'dir.

Malzemeler

Doğal Kaplama - Masa - Toplantı Masası - Depolama - Sehpa



KESTANE

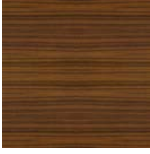

TEAK



SAPELLİ



CEVİZ

Vinterio Kaplama - Masa - Toplantı Masası - Depolama - Sehpa



V. SYCAMORE



V. BEYAZ MEŞE



V. CEVİZ



V. İSLİ MEŞE

Rekompoze Kaplama - Masa - Toplantı Masası - Depolama - Sehpa



R.CEVİZ

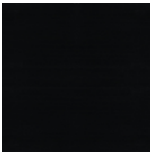

R.SİYAH



R.MEŞE

Malzemeler

Lake - Depolama (Gövde)



RAL.0001



RAL.0040



RAL.8019



RAL.9016



RAL.0020



RAL.9006

Toz Boya - Ayak



N.0001



N.0040



N.8019



N.9010



N.0020



N.9006

Boyalı Cam - Toplantı Masası - Sehpa

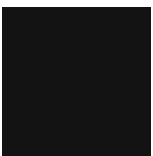

RAL.0001



RAL.0040



RAL.8019



RAL.9010



RAL.0020

Uyarılar

Kullanım Önerileri

- Ürünün dış kaplamaları sert cisimlerle basınç uygulanarak çizilmemelidir.
- Ürün direkt olarak ısıya maruz bırakılmamalıdır. Üzerine sıcak cisimler konulmamalıdır.
- Ürün ateşe ve suya maruz bırakılmamalıdır.
- Ürünün nemli veya rutubetli ortamlarda bulundurulmaması gerekmektedir.
- Ürünlerin temizliği nemli veya kuru bezle rahatlıkla yapılabilir.
- Ürün, fonksiyonu dışındaki işler için kullanılmamalıdır.
- Ürüne taşıyamayacağı ağırlıkta yük konulmamalıdır.
- Ürününüz monte ve de-monte edilebilmektedir.
- Ürün monte edilmiş halde çekilmemeli ve sürüklenmemelidir.
- Masa bağlantı ilavesi eklendiğinde bu ilavelere bir masanın kaldırabileceğinden daha ağır yük konulmamalıdır.
- Ürün kaplamasına etiket, çıkartma vb. yapışkanlı materyal yapıştırılmamalıdır. Ürüne zarar verebilir.

